

Quality Regulations for Profiles

September 2011



Contents

Preface	3
1. Terms and Definitions	5
1.1 Third parties	5
1.2 Independent laboratories	5
1.3 Independent experts	5
1.4 Independent auditing bodies	6
1.5 Evaluation report	6
1.6 Assessment report	6
1.7 Test report	6
1.8 Notified body	6
2. Basis of the Quality Assurance System	7
2.1 General	7
2.2 Requirements for third parties for testing	7
2.3 Requirements for third parties for evaluation and assessment	8
2.4 Requirements for independent experts in the Quality Committee	8
2.5 Technical requirements	8
3. EPAQ requirements for material properties	10
3.1 Nominal thickness	10
3.2 Reaction to fire	10
4. Control of material properties	11
4.1 General	11
4.2 Base material	11
4.3 Initial Type Testing	12
4.4 Initial Inspection and External Quality Control	12
4.5 FPC procedures	13
4.6 Measurement of tolerances	14
5. Procedures	19
5.1 Award and maintenance of the Quality Label	19
5.2 Use of the Quality Label	19
Annex A	21
Table A1: Values under control of EPAQ - needed for different applications	21
Table A2: ITT procedures for base material	22
Table A3: ITT procedures for profiles	23
Table A4: Dimensional tolerances for trapezoidal profiles, test specimens, type of the test and conditions	24
Table A5: Dimensional tolerances for sinusoidal profiles, test specimens, type of the test and conditions	26
Table A6: Dimensional tolerances for cassettes, liner trays, test specimens, type of the test and conditions	27
Table A7: Dimensional tolerances for tiles, test specimens, type of tests and conditions	29
Table A8: FPC procedures for base material and external control	30
Table A9: FPC procedures for profiles and external control	31

Annex B	33
B.1 Dimensions of trapezoidal profiles	33
B.2 Dimensions of sinusoidal profiles.....	37
B.3 Dimensions of cassettes and liner trays.....	40

Preface

These Quality Regulations are valid for profiles which are covered by the scopes of

- EN 14782 – Self-supporting metal sheet for roofing, external cladding and internal lining for self-supporting profiles
- EN 1090 - Execution of steel structures and aluminium structures for load-bearing profiles

For these products EN 14782 and EN 1090 are the technical basis and these Quality Regulations apply.

The regulations for self-supporting profiles are also valid for load-bearing profiles if there are no other requirements mentioned in these regulations. Therefore regulations based on EN 14782 are also valid for profiles covered by EN 1090 if there are no deviating rules in these Quality Regulations.

The manufacturer has to decide – also for the CE-mark - under which standard his products have to be produced.

It is the intention of this Quality Regulations to establish a quality assurance system for profiles which is mainly based on independent third party control.

Regarding EN 14782 the Attestation of Conformity (AoC) system is 4 with the exception of fire properties (AoC system 3 - 4) and dangerous substances (AoC system 3). Therefore no notified body exists who can be notified for mechanical properties on the basis of EN 14782.

Regarding EN 1090 the Attestation of Conformity (AoC) system is 2+.

The task of EPAQ is to get experienced third parties to ensure a quality assurance system which is comparable to AoC system 1+ for mechanical properties.

Standards are established for third parties to guarantee work on an equal and comparable level.

1. Terms and Definitions

For the purposes of this document, the following terms and definitions apply.

1.1 Third parties

The tasks of third parties are:

- initial type testing and writing the test report
- evaluation and preparation of evaluation report of ITT (task only for independent experts)
- responsibility for and attending of initial inspection including assessment report
- responsibility for and attending of external quality control including evaluation report and assessment report for external quality control.

Third parties may be recognized for one or more fields of experience of the above mentioned tasks with regard to profiles.

Third parties are

- independent laboratories with sufficient experience in profile testing and evaluation of profile testing, or
- a combination of an experienced independent expert acting together with an inexperienced or possibly not impartial laboratory, or
- independent laboratories or independent companies for assessment of factory production control.

1.2 Independent laboratories

Independent laboratories that are working on the basis of the EPAQ-regulations have to be national institutions that are member of EOTA or that are approved for testing profiles by a national institution that is member of EOTA or is accredited by an EA-member. If an independent laboratory does not fulfil this requirement, a committee of the third parties who are working under the scheme of this Quality Regulations have to decide on the independent laboratory by checking its competence in testing and/or evaluating test reports on profiles.

Independent laboratories are not allowed to evaluate and to prepare the evaluation report of ITT. This task can only be done by an independent expert.

1.3 Independent experts

An independent expert is an individual or an individual within a testing laboratory with recognized knowledge in profile technology. In case of FPC assessment, it is also possible that the responsible independent expert is a member of an auditing body.

The independent experts of the Quality Committee have to decide on the persons with enough knowledge on profiles who want to become independent experts for one or more of the following tasks:

- Responsibility for and attending of initial type testing according to 2.2.4 including test report
- Evaluation and preparation of evaluation report of initial type testing
- Responsibility for and attending of initial inspection including assessment report
- Responsibility for and attending of external quality control including evaluation report and assessment report for external quality control
- Checking and confirmation of test-, evaluation- and assessment reports for initial type testing, initial inspection and quality control tests

1.4 Independent auditing bodies

In case of FPC assessment, the auditing body is responsible for assessment and writing the assessment report. The independent experts of the Quality Committee decide on the auditing bodies that are working under the EPAQ-scheme.

1.5 Evaluation report

Report worked out by an independent expert determining basic values and properties as a base for awarding and maintenance of the Quality Label on the base of the relevant assessment and test reports.

1.6 Assessment report

Reviews result from external quality control and FPC in comparison to declared values on the CE-mark and in comparison to the requirements of these Quality Regulations.

1.7 Test report

Includes all basic test results without calculation of statistical evaluation and other further steps.

1.8 Notified body

Laboratories accredited under CPD; here particularly laboratories involved in fire testing.

2. Basis of the Quality Assurance System

2.1 General

2.1.1 Technical basis

Technical basis of the Quality Assurance System of EPAQ for profiles is the European standard

- EN 14782 for self-supporting profiles
- EN 1090 for load-bearing profiles

when there are no special regulations given by the Quality Committee. The rules of the Quality Regulations are valid for products used for applications which are for normal European outdoor and indoor conditions in normal buildings.

2.1.2 Legal basis

The Guidance Papers of the European Commission are basis of these Quality Regulations and have to be followed for the quality assurance work of EPAQ:

- Guidance Paper B
The definition of Factory Production Control in technical specifications for construction products
- Guidance Paper K
The Attestation of Conformity Systems and the role and tasks of the Notified Bodies in the field of the Construction Products Directive.
- Guidance Paper M
Conformity assessment under the CPD: Initial type-testing and Factory Production Control

2.1.3 Quality management system

Companies which are member of EPAQ have to have a quality management system ISO 9001-2000 or higher; or have to follow the requirements of a quality management system ISO 9001-2000 or higher, especially the requirements mentioned in EN 14782, 6.3.2.

2.2 Requirements for third parties for testing

2.2.1 General requirements

Third parties who carry out the testing have to work in accordance to the requirements of EN ISO 17020 or EN 45011 and EN ISO 17025. The Testing Rules of EPAQ have to be applied by testing profiles. It is not permitted to deviate from the testing procedures established in EN 14782 for self-supporting profiles and EN 1090 for load-bearing profiles and completed by the EPAQ Testing Rules.

2.2.2 Third parties for testing

Third parties are either independent laboratories with sufficient experience in profile testing or with sufficient experience in profile testing for external control according to 2.2.3 or a combination of an experienced independent expert acting

together with an inexperienced or possibly not impartial laboratory according to 2.2.4.

2.2.3 Requirements for independent laboratories

Independent laboratories for testing must fulfil the requirements according to 1.2.

2.2.4 Requirements for independent experts working with laboratories

Independent experts working together with laboratories can form a third party body. The independent expert can work with external laboratories, which either do not conform with 2.2.3 or do not have the necessary experience to perform adequate testing or he can work with a manufacturer's laboratory, where the independent expert insures adequacy of testing facilities and procedures as well as independency of the laboratory.

2.3 Requirements for third parties for evaluation and assessment

2.3.1 General requirements

Evaluation work is undertaken by independent experts (see 1.3), assessment work is undertaken by independent laboratories (see 1.2) or in case of initial inspection and assessment only, auditing bodies (see 1.4).

2.3.2 Requirements for independent laboratories

Independent laboratories must fulfil the requirements according to 1.2.

2.3.3 Requirements for independent experts for evaluation and assessment

Independent experts for evaluation and assessment must fulfil the requirements according to 1.3.

2.3.4 Requirements for auditing bodies for assessment

Auditing bodies for assessment must fulfil the requirements according to 1.4.

2.4 Requirements for independent experts in the Quality Committee

2.4.1 Two independent experts are elected members of the Quality Committee. They have to be elected by the General Assembly (see EPAQ-Statutes, 9.).

2.4.2 The independent experts of the Quality Committee have to have good experience in testing and evaluating test results of profiles.

2.5 Technical requirements

2.5.1 Table A1 shows a list of properties which are under control of EPAQ in reliance on different applications. Frequency of testing and the number of samples for FPC and external control is regulated in Table A8 and A9.

2.5.2 In case of:

- dimensional tolerances,
- mechanical strength and modulus,
- durability, where required

The parties involved in the voluntary quality assurance system of EPAQ have the following tasks (see Table 1 below):

Duty	Outcome	Party involved
ITT tests	Test report	Third party according to 2.2
ITT test evaluation	Evaluation report	Third party according to 2.3
Initial inspection	Assessment report	Third party according to 2.3
External Quality Control including assessment of FPC	Evaluation report	Third party according to 2.2 (or for assessment of FPC only, auditing body according to 2.3)

Table 1: Tasks of involved parties concerning tolerances, mechanical characteristics, durability

2.5.3 In case of:

- Reaction to fire
- Fire resistance
- External fire exposure,

Test reports and classification reports are to be delivered if no CWFT-decision exists.

2.5.4 In case of:

All other properties (e. g. tightness performance) the parties involved in the voluntary quality assurance system of EPAQ have the following tasks (see Table 2 below).

Duty	Outcome	Party involved
ITT tests	Test report	Third party according to 2.2
ITT test evaluation	Evaluation report	Third party according to 2.3
FPC (where required)	Evaluation report	Third party according to 2.2 (or auditing body) where required (see Table A3)

Table 2: Tasks of involved parties concerning other properties

3. EPAQ requirements for material properties

3.1 Nominal thickness

The nominal thickness of the self-supporting metal sheet (excluding any organic, inorganic or multi-layer coating), as defined in the relevant material standards listed in EN 506, EN 508-1, EN 508-2 and EN 508-3, shall be for all applications equal to or greater than:

- Aluminium: 0,7 mm
- Stainless steel: 0,7 mm
- Steel: 0,6 mm

3.2 Reaction to fire

Profiles must have a minimum class of reaction to fire behaviour of C-s3, d0.

4. Control of material properties

4.1 General

The control of the production of profiles is carried out by means of the plant's own production control and external control in accordance with the following stipulations of these regulations.

The manufacturer must conclude a control agreement with EPAQ in order to bear the EPAQ quality label, who for his part must commission the appropriate third parties with the control task, in order to be able to observe the requirements in accordance with the Quality Regulations.

After ensuring that the third party fulfils the requirements according to chapter 1 EPAQ has to make a contract with the third parties chosen by the manufacturer to ensure that the quality assurance will be on the basis of the EPAQ-regulations.

The implementation of the inspections and the type of documentation is regulated by the Quality Committee in agreement with the third parties which carry out the external control.

The reports of assessment and external quality control shall be retained for at least five years.

The third parties have to have meetings to coordinate their work if required by EPAQ. These meetings ought to be held in combination with the meetings of the Quality Committee.

4.2 Base material

If the finished product manufacturer buys base materials whose characteristics have already been determined in accordance with the provisions of EN 14782, and are declared by the base material supplier with an inspection document 3.1 according to EN 10204, the finished product manufacturer's system requires only a document check to ensure that the characteristics meet the product manufacturer's specifications, provided that the production process for the finished product does not change in an unfavourable way these characteristics.

The inspection document 3.1 shall contain the following data:

- Name of the coil coater / producer
- Coil no or coil batch number
- Indication of the type and grade of material according to EN 14782
- Indication of the nominal layer weight of the metallic protective layers in accordance with EN 10346
- Format and nominal sheet thickness (t_N) (in mm respectively)
- Coating system
- Determined layer weight of the metal protective layer (g/m^2) in accordance with EN 10346
- Determined thickness of the organic coating visible side/rear side in μm

- Determined values of the mechanical material properties (see also EN 10346)
 - Yield strength or 0,2 %-proof strength ($R_{eH}/R_{p0,2}$) in N/mm²
 - Tensile strength (R_m) in N/mm²
 - Elongation $A_{80\text{ mm}}$ in %

In case of not having an inspection document 3.1 **all** data mentioned above has to be determined by the manufacturer himself.

In case of an incomplete inspection document not containing all data mentioned above, the missing data has to be determined by the manufacturer himself.

4.3 Initial Type Testing

4.3.1 General

All characteristics in Table 2 and 3 of EN 14782 or chapter 6.2 and Table 1 of EN 1090, where relevant, shall be subjected to ITT tests with the exception of fire performance when using the CWFT option, where measurement in accordance with C.3 of EN 14782 is required to ensure that the product meets the definition required for CWFT.

4.3.2 Additional requirements of EPAQ

Dimensional tolerances are subjected to ITT-tests with additional EPAQ requirements, see Table A3 to A7.

4.3.3 Responsibility

The ITT tests must be done by third parties for testing according to 2.2. The evaluation and preparation of the evaluation report must be done by third parties for evaluation and assessment according to 2.3.

4.3.4 ITT-tests

The ITT-tests can be made in a laboratory or in a factory of the manufacturer. The presence of an independent representative of a third party is absolute necessary for calibration and supervision of the tests.

4.4 Initial Inspection and External Quality Control

4.4.1 General

Prior to the first external quality control an initial inspection shall be conducted.

The standard inspection including audit-testing of samples is carried out at least twice a year in the factory of the quality label user based on the control agreement.

4.4.2 Responsibility

The Initial Inspection and External Quality Control tests must be done by third parties for testing according to 2.2.

4.4.3 Procedures

The external quality control needs to be conducted in accordance with the testing regime described in Table A8 and A9. The necessary samples are to be taken from the production process. Sampling and testing has to be done by a third party or can be done by the manufacturer in the presence and under the responsibility of a third party.

In each profile production plant the internal factory production control must be confirmed by external quality control at least twice a year. The responsible third party shall be physically present in the plant twice a year.

The record of the results of the factory production control must be submitted to the third party by the manufacturer.

The efficiency of an existing quality management system must be shown by certificate or has to be checked by the third party according to clause 2.1.3.

In the case of External Quality Control samples from the current production process must be selected in such a way that all profiles (see also EN 14782, Table 5) are selected in the course of one year.

The results of the external control are recorded in the evaluation report of the third party. The manufacturer and the Secretary of EPAQ simultaneously receive one copy of the evaluation report.

The acceptance of evaluation of the results is incumbent upon the Quality Committee.

In the case of inadequate test results within the framework of the external control the responsible third party must inform the independent expert in the Quality Committee and the manufacturer must immediately initiate the necessary measures in order to remedy the defects.

4.4.4 Evaluation of test results for mechanical properties

No individual test result in external quality control must be poorer than the value declared. Otherwise additional samples need to be taken, tested and the 5 %-fractile value needs to be determined anew. The resulting characteristic value must not be poorer than the declared value. Else the profile loses conformity with the quality label. For the anew determination of the 5%-fractile it may be assumed that $k = 1,65$.

4.4.5 Evaluation of test results for other properties

No individual test result in external quality control must be poorer than the value declared. Otherwise additional samples need to be tested.

4.5 FPC procedures

4.5.1 General

The manufacturer shall establish procedures to ensure that the stated values of all of the characteristics are maintained in accordance with chapter 6.3 of EN 14782 or chapter 6.3 of EN 1090. Table 4 and 5 of EN 14782 or Table 2 of EN 1090 show the test methods which must be done for FPC and external control, the number of specimens and the frequency of FPC and external control. The FPC has to follow the instructions of Guidance Paper B of the European Commission.

4.5.2 FPC for safety in fire characteristics

FPC for safety in fire characteristics shall be carried out according to EN 14782, Table 5.

4.6 Measurement of tolerances

4.6.1 General

The measurements are carried out in accordance with the FPC and the external control.

4.6.2 Materials

The inspection of the material properties required for the basic material see 4.2.

4.6.3 Sheet thickness

The measurement of sheet thickness is carried out in accordance with EN 10143 and indeed prior to the cold forming, see also Table A8.

If measurements are made of profiled sheet then the measurement of the sheet thickness is carried out at least 3 measuring points on one end of profile, Annex B, Figure B1.2, B2.1, B3.2. The average value is deemed to be the sheet thickness but no individual value should be beneath the stipulated permissible minus dimension.

4.6.4 Trapezoidal profiles

4.6.4.1 General information

The inspection of the dimensional accuracy of the dimensions of the trapezoidal profiles is carried out on the basis of spot checks in accordance with the following regulations during the manufacturing process: All the measurements are carried out 200 mm away from an end of profile, if nothing else is indicated.

4.6.4.2 Depth of profile h

The distance between the surfaces of the same side of the upper and lower flange is deemed as being the depth of profile h .

The measurement is carried out in accordance with Annex B, Figure B1.4 and B1.5.

4.6.4.3 Pitch of the profile p

The pitch of the profile p shall be the distances between the centres of adjacent ribs, measured at 200 mm from sheet ends, see Annex B, Figure B1.10.

4.6.4.4 Cover width w

The cover width w indicates the modular dimension for the width. It is stated by the manufacturer.

The cover width is measured 200 mm from the sheet ends and in the profile centre of an evenly supported structural member, see Annex B, Figure B1.6.

4.6.4.5 Width of crown and valley

The widths of crown and valley b must be measured on all the profile ribs, see Annex B, Figure B1.1.

4.6.4.6 Radius of bends r

The measurement of the radius is carried out on the inside of the bend in accordance with the positions displayed in Annex B, Figure B1.7.

- 4.6.4.7 Position of flange stiffeners b_k and depth of flange stiffeners h_r
The position b_k and the height h_r must be measured on all crowns, see Annex B, Figure B1.1.
- 4.6.4.8 Position of web stiffeners h_a , h_b
With respect to the position h_a , h_b , the vertical distance of the start of the web from the external surface of the upper or lower flange applies, see Annex B, Figure B1.1.
The length h_{sa} , h_{sb} , see Annex B, Figure B1.1, is the calculated difference between the vertical distances from the start and end of the web and the external surface of the upper or lower flange that has been measured.
The distance of the neighbouring parallel displaced web surfaces applies as the displacement v_{sa} , v_{sb} , see Annex B, Figure B1.1, measured between the respective sheet external and internal surfaces.
In the case of profiles with sectional differing web inclines the average value from the two measurements from both sides of the web applies as the displacement.
- 4.6.4.9 Contraction or bulging of the profile w_3
The third measurement w_3 of cover width shall be made across the centre line of the sheet (see 4.6.4.4) to determine the contraction or bulging of the profile. This w_3 measurement shall be within the stated tolerance referred to the average value for w_1 and w_2 .
- 4.6.4.10 Crown curvature h_e
The crown curvature h_e must be measured on all crowns, see Annex B, Figure B1.1.
- 4.6.4.11 Length of the profile l
The length of the profile l must be determined on the middle rib on the profile, see Annex B, Figure B1.6.
- 4.6.4.12 Deviation from squareness S
The determination of the deviation from squareness S must be controlled in accordance with Annex B, Figure B1.9.
- 4.6.4.13 Longitudinal edge upstand h_u
The longitudinal edge upstand h_u is measured on the longitudinal edge, see Annex B, Figure B1.1.
- 4.6.4.14 Deviation of side lap D
The deviation of side lap D is defined in Annex B, Figure B1.3. It is determined by means of the straightness of the longitudinal edge.
- 4.6.4.15 Longitudinal edge width b_{uf}
In the case of lower profile flange with the transverse bead the dimension b_{uf} must be agreed upon with the third party, otherwise it will be inspected on the basis of the flange widths b_u in accordance with the existing formula, see Annex B, Figure B1.1, Table A4.

- 4.6.4.16 Deviation from straightness δ
The deviation from straightness δ is measured on the longitudinal edge, see Annex B, Figure B1.8.
- 4.6.4.17 Position and dimension of perforation
The position and dimension of perforation of acoustic trapezoidal profiles must be inspected in accordance with Annex B, Figure B1.11.
- 4.6.5 Sinusoidal profiles
- 4.6.5.1 General information
The inspection of the dimensional accuracy of the dimensions of the sinusoidal profiles is carried out on the basis of spot checks in accordance with the following regulations during the manufacturing process: All the measurements are carried out 200 mm away from a profile end, if nothing else is indicated.
- 4.6.5.2 Depth of profile h
The distance between crowns and valleys is deemed as being the depth of profile h .
The measurement is carried out in accordance with Annex B, Figure B2.2, by means of the application of a measuring aid upon the wave high points. The measurement is carried out to the wave trough.
- 4.6.5.3 Pitch of the profile p
The pitch of the profile p shall be the distances between the centres of adjacent waves, measured at 200 mm from sheet ends, see Annex B, Figure B2.3.
- 4.6.5.4 Cover width w
The cover width w indicates the distance of the high points of both external waves.
The cover width w is measured 200 mm from the profile ends and in the profile centre of an evenly supported structural member respectively. The cover width is determined at the upper side of the profile, see Annex B, Figure B2.4.
- 4.6.5.5 Radius of bends r
The measurement of the radius is carried out at the positions shown in Annex B, Figure B2.5 for each indicated wave on the upper and lower side of the profile by means of radius gauges.
- 4.6.5.6 Deviation from squareness S
The determination of the deviation from squareness S must be controlled in accordance with Annex B, Figure B2.7.
- 4.6.5.7 Length of the profile l
The length of the profile l must be determined on the middle rib on the profile, see Annex B, Figure B2.6.
- 4.6.5.8 Deviation of side lap D
The deviation of side lap D is defined in Annex B, Figure B2.8. It is determined by means of the straightness of the longitudinal edge.

- 4.6.5.9 Contraction or bulging of the profile w_3
The third measurement w_3 of cover width shall be made across the centre line of the sheet (see 4.6.5.4) to determine the contraction or bulging of the profile. This w_3 measurement shall be within the stated tolerance referred to the average value for w_1 and w_2 .
- 4.6.6 Cassettes and liner trays
- 4.6.6.1 General information
The inspection of the dimensional accuracy is carried out on the basis of spot checks in accordance with the following regulations during the manufacturing process: All the measurements are carried out 200 mm away from a profile end, if nothing else is indicated.
- 4.6.6.2 Depth of profile h
The distance between the surfaces of the same side of the upper and lower flange is deemed as being the depth of profile h .
The measurement is carried out in accordance with Annex B, Figure B3.1 and B3.2.
- 4.6.6.3 Position of flange stiffeners b_k and depth of flange stiffeners h_r
The position b_k and the height h_r must be measured in accordance with Annex B, Figure B3.1.
- 4.6.6.4 Position of web stiffeners h_a , h_b and depth of web stiffeners v_{sa} , v_{sb}
The vertical distance of the stiffener from the external surface of the broad flange h_a , h_b and the depth of the stiffeners v_{sa} , v_{sb} must be measured according to Annex B, Figure B3.1.
- 4.6.6.5 Width of flanges b_s
The measurements are carried out on both flanges, see Annex B, Figure B3.1.
- 4.6.6.6 Cover width w
The cover width is measured 200 mm from the sheet ends and in the profile centre of an evenly supported element, see Annex B, Figure B3.2 and B3.3.
- 4.6.6.7 Radius of bends r
The radius r is measured 200 mm from the sheet ends and in the profile centre in accordance with the positions displayed in Annex B, Figure B3.1.
- 4.6.6.8 Length of the profile l
The length of the profile l must be measured in the centre of the profile, see Annex B, Figure B3.3.
- 4.6.6.9 Deviation of side lap D
The deviation of side lap D is defined in Annex B, Figure B3.4. It is determined by means of the straightness of the longitudinal edge.
- 4.6.6.10 Longitudinal edge upstand s
The longitudinal edge upstand s is measured on the longitudinal edge, see Annex B, Figure B3.1.

- 4.6.6.11 Corner angle flange/web φ
The corner angle φ is measured according to Annex B, Figure B3.5.
- 4.6.6.12 Deflection of flange f_s
The deflection of the narrow upper flange f_s may not exceed a maximum level of $l/300 \leq \pm 20$ mm, see Annex B, Figure B3.3.
- 4.6.6.13 Lateral curvature f_q
The lateral curvature $\pm f_q$ has to be determined at the centre of a profile, which is supported at a distance interval L , and attached at the points of support of the pressed down profile in the vertical fixed position with fixation of the webs in 90° (e. g. with a continuous cold formed angle), see Annex B, Figure B3.6
- 4.6.6.14 Longitudinal corrugation f_w
The longitudinal corrugation f_w is determined by means of the installation of an appropriate measuring device at the 2 highest peaks. The completed measurement to the deepest wave trough from the measuring line is the measurement value for the lengthwise waviness f_w , see Annex B, Figure B3.6.
- 4.6.6.15 Position and dimension of perforation
The position and dimension of perforation of acoustic profiles must be inspected in accordance with Annex B, Figure B3.7.

5. Procedures

5.1 Award and maintenance of the Quality Label

The principles are laid down in the Procedural Regulations of EPAQ.

The following procedure to get a quality label has to be followed:

5.1.1 Testing by a third party according to 4.2

The way of testing can be handled as follows:

5.1.1.1 The third party in form of an independent laboratory is responsible. The duty of the third party is to carry out the tests and to write the test-report (see 2.2.3).

5.1.1.2 The third party in form of an independent expert together with a laboratory not able to fulfil the requirements of 2.2.3 (see 2.2.4) is responsible.

The duty of the laboratory (e.g. manufacturer's laboratory) is to carry out the tests under supervision and responsibility of an independent expert. The independent expert is responsible for the test report.

5.1.2 Evaluation of the test results, given in a separate evaluation report by an independent expert (see 2.3).

5.1.3 Checking of the evaluation report (including test report and/or assessment report) by an independent expert of the Quality Committee (see 2.4). This independent expert must be different from the independent expert who has written the evaluation report.

5.1.4 The independent experts of the Quality Committee can decide on additional independent experts for checking the evaluation reports.

5.1.5 An independent expert has to do an initial inspection of FPC. In case of already approved systems confirmed by the Quality Committee, this inspection is not obligatory.

5.1.6 The independent experts of the Quality Committee decide on the award of the quality label.

5.1.7 In case of rejection, the manufacturer has the possibility to file an objection to this decision. The manufacturer has to present arguments in favour of the award of the quality label for his products on the next meeting of the Quality Committee.

5.1.8 The quality certificate has to be signed by the Secretary General and the independent expert mentioned in 5.1.3.

5.2 Use of the Quality Label

5.2.1 Quality label users may only use the quality label for products which comply with the Quality Regulations and for which the quality label has been awarded.

5.2.2 The "European Quality Assurance Association for Panels and Profiles" alone has the right to allow a means of identification of the quality label to be produced and supplied to the user of the quality label or to allow the label to be handed out and the use of it to be set out in more detail.

- 5.2.3 The Managing Committee may issue special rules for the use of the quality label in advertising, so that the integrity of competition is preserved and misuse is prevented. Individual advertising must not be hampered by this, although the same maxim regarding the integrity of competition still applies.
- 5.2.4 If the right to use the quality label is withdrawn, the award document for the quality label has to be returned. The same applies if the right to use the label has expired for any other reason.

Annex A

Table A1: Values under control of EPAQ - needed for different applications

No.	Characteristic	External walls	Internal walls	Ceilings	Roofs
1	Quality of metal	yes	yes	yes	yes
2	Thickness of metal	yes	yes	yes	yes
3	Mechanical resistance Yield strength/grade of metal	yes	yes	yes	yes
4	Dimensional change (Declaration)	yes	yes	yes	yes
5	Durability/quality of the coating (Declaration)	yes	yes	yes	yes
6	Mechanical resistance Resistance to concentrated forces	no	no	no	yes
7	Water permeability Vapour and air permeability (Visual assessment)	yes	yes	yes	yes
8	Dimensional tolerances	yes	yes	yes	yes
9	External fire performance – certification	no	no	no	yes
10	Reaction to fire – certification	yes	yes	yes	yes
11	Release of dangerous substances	Where required			

Table A2: ITT procedures for base material

Type of test	Requirement clause clause of EN 14782	Test Method acc. to EN 14782	Minimum number of specimens		
			With traceability system but without base material manufacturer's inspection document ^c	With traceability system ^d and base material manufacturer's inspection document ^c	Compliance criteria and specific conditions
Quality of metal ^a	4.1	Visual inspection	1	1	Manufacturer's declaration
Thickness	4.2	See 4.2	3	1 ^e	Within the manufacturer's stated tolerance.
Mechanical resistance Yield strength/grade of metal	4.3	EN 10002-1	3	1 ^e	Manufacturer's declaration
Dimensional change	4.6	-	-	-	Manufacturer's declaration
Durability /quality of coating	4.8	See 4.8	-	-	Declaration or compliance with appropriate national technical specification
Release of regulated dangerous substances	4.11	-	-	- ^b	As appropriate when national provisions exist

a This concerns the quality of the base material (no pin-holes, micro-holes, pits, etc.).

b In this case, the finished product manufacturer shall verify that the inspection document 3.1 in accordance with EN 10204 indicates that the base material (e. g. coils, sheets) has the characteristics that he need to produce the finished product.

c Inspection document 3.1 in accordance with EN 10204

d These tests shall be done by the finished product manufacturer

e In this case, the finished product manufacturer shall verify that the inspection document 3.1 in accordance with EN 10204 indicates that the base material (e. g. coils, sheets) has the characteristics that he need to produce the finished product and shall perform additional test(s)

Table A3: ITT procedures for profiles

Type of test	Requirement clause of EN 14782	Test Method acc. to EN 14782	Minimum number of specimens	Compliance criteria and specific conditions
Mechanical resistance Resistance to concentrated forces ^a	4.3	Annex B	B.5 of EN 14782	All test results \geq manufacturer's stated value: a span compatible with a force of 1,2 kN
Water permeability	4.4	Visual inspections	Random	Pass
Dimensional tolerances: Initial set up of the manufacturing machines	4.7 and EPAQ	EN 506, EN 508-1, EN 508-2 or EN 508-3	3	3 of minimum and maximum sheet thickness All test results within EPAQ's tolerances
External fire performance ^a	4.9 ^b	ENV 1187	See EN 13501-5	Classification in accordance with EN 13501-5
Reaction to fire	4.10 ^b	EN 13501-1 and Annex C	See EN 13501-1	Classification in accordance with EN 13501-1
<p>a Applies only to roofing products.</p> <p>b For products requiring testing.</p>				

Table A4: Dimensional tolerances for trapezoidal profiles, test specimens, type of the test and conditions

Title	Symbols	Test method acc. to EN 508 Annex D	Profiles according to EN 14782 Values of EN 508 or new EPAQ-values (grey)	Profiles according to EN 1090 New EPAQ-values (grey)
Depth of profile	h	D.1.2	$h \leq 50 \text{ mm}$ $50 \text{ mm} < h \leq 100 \text{ mm}$ $h > 100 \text{ mm}$	$\pm 1,0 \text{ mm}$ $\pm 1,5 \text{ mm}$ $\pm 2,0 \text{ mm}$
Depth of stiffeners	h_r v_s	D.1.3	$\pm 1 \text{ mm}$	$+3 \text{ mm}$ -1 mm $+2$ $-0,15 \times v \leq 1 \text{ mm}$
Position of stiffeners	$h_a, h_b,$ $h_{sa}, h_{sb} b_k,$		$\pm 3 \text{ mm}$	$\pm 3 \text{ mm}$
Pitch of the profile	p	D.1.4	$h \leq 50 \text{ mm}$ $\pm 2,0 \text{ mm}$ $50 \text{ mm} < h \leq 100 \text{ mm}$ $\pm 3,0 \text{ mm}$ $h > 100 \text{ mm}$ $\pm 4,0 \text{ mm}$	no requirement
Widths of crown and valley	b	D.1.5	$+2 \text{ mm}$ $- 1 \text{ mm}$	$+4 \text{ mm}$ -1 mm
Cover width	w	D.1.6	$h \leq 50 \text{ mm}$ $\pm 5,0 \text{ mm}$ $h > 50 \text{ mm}$ $\pm 0,1 \times h \leq 15 \text{ mm}$	
Contraction or bulging	w_3		$(w_1 + w_2)/2 - \text{tolerance} \leq w_3 \leq (w_1 + w_2)/2 + \text{tolerance}$	
Radius of bends	r	D.1.7	$+2 \text{ mm}$ 0 mm	$\pm 2 \text{ mm}$
Deviation from straightness	δ	D.1.8	2,0 mm / m of sheet length not exceeding 10 mm	
Deviation from squareness	S	D.2.7	$S \leq 0,005 \times w$	no requirement
Length of the profile	l	D.1.10	$L \leq 3000 \text{ mm}$ $L > 3000 \text{ mm}$	$+10 \text{ mm}$ -5 mm $+ 20 \text{ mm}$ -5 mm

Title	Symbols	Test method acc. to EN 508 Annex D	Profiles according to EN 14782 Values of EN 508 or new EPAQ-values (grey)	Profiles according to EN 1090 New EPAQ-values (grey)
Deviation of side lap	D	D.1.11	D ≤ ± 2,0 mm on a length of 500 mm	
Longitudinal edge upstand	h _u		≥ 10 mm	
Longitudinal edge width	b _{uf}		b _u ≤ 30 mm b _u /2 + 5 ≤ b _{uf} ≤ b _u - 5 b _u > 30 mm 20 ≤ b _{uf} ≤ b _u - 5	
Crown curvature	h _e		± 3 mm	
Hole diameter	d _n		≤ Ø 5 mm ± 0,2 mm > Ø 5 mm + 0,2 mm -0,4 mm In case of additional coating after profiling the measurement must be done without additional coating	
Hole pitch	u _x		+2,0 / -1,0 mm	
Offset	V		± 2,0 mm	
Row spacing	u _y		± 2,0 mm	
Edge spacing	e _g , e _s		The minimum values to be complied will be specified during ITT	
Total number of rows (transversal direction)			± 0 The number must be specified by the manufacturer during ITT ± 3% In case of completely perforated sheets	
Total number of rows per meter (longitudinal direction)			± 3% The number must be specified by the manufacturer during ITT	

Table A5: Dimensional tolerances for sinusoidal profiles, test specimens, type of the test and conditions

Title	Symbols	Test method acc. to EN 508 Annex D	Values of EN 508 or new EPAQ-values (grey)						
Depth of profile	h		<table border="0"> <tr> <td>$h \leq 50 \text{ mm}$</td> <td>$\pm 1,0 \text{ mm}$</td> </tr> <tr> <td>$50 \text{ mm} < h \leq 100 \text{ mm}$</td> <td>$\pm 1,5 \text{ mm}$</td> </tr> <tr> <td>$h > 100 \text{ mm}$</td> <td>$\pm 2,0 \text{ mm}$</td> </tr> </table>	$h \leq 50 \text{ mm}$	$\pm 1,0 \text{ mm}$	$50 \text{ mm} < h \leq 100 \text{ mm}$	$\pm 1,5 \text{ mm}$	$h > 100 \text{ mm}$	$\pm 2,0 \text{ mm}$
$h \leq 50 \text{ mm}$	$\pm 1,0 \text{ mm}$								
$50 \text{ mm} < h \leq 100 \text{ mm}$	$\pm 1,5 \text{ mm}$								
$h > 100 \text{ mm}$	$\pm 2,0 \text{ mm}$								
Pitch of the profile	p		$\pm 3,0 \text{ mm}$						
Cover width	w		$\pm 0,01 \times b$						
Radius of bends	r		$\pm 10\%$						
Deviation from squareness	S		$S \leq 0,005 \times w$						
Length of the profile	l		<table border="0"> <tr> <td>$L \leq 3000 \text{ mm}$</td> <td>+10 mm</td> <td>-5 mm</td> </tr> <tr> <td>$L > 3000 \text{ mm}$</td> <td>+ 20 mm</td> <td>-5 mm</td> </tr> </table>	$L \leq 3000 \text{ mm}$	+10 mm	-5 mm	$L > 3000 \text{ mm}$	+ 20 mm	-5 mm
$L \leq 3000 \text{ mm}$	+10 mm	-5 mm							
$L > 3000 \text{ mm}$	+ 20 mm	-5 mm							
Deviation of side lap	D		$D \leq \pm 2,0 \text{ mm}$ on a length of 500 mm						
Cover width difference	Δw		$w_3 \leq (w_1 + w_2)/2 \pm 5 \text{ mm}$						

Table A6: Dimensional tolerances for cassettes, liner trays, test specimens, type of the test and conditions

Title	Symbols	Test method acc. to EN 508 Annex D	Profiles according to EN 14782	
			Values of EN 508 or new EPAQ-values (grey)	Profiles according to EN 1090 New EPAQ-values (grey)
Depth of profile	h	D.1.2	h ≤ 50 mm 50 mm < h ≤ 100 mm h > 100 mm	± 1,0 mm ± 1,5 mm ± 2,0 mm
Depth of stiffeners	h _r v _s	D.1.3	± 1 mm	+3 mm -1 mm +2 -0,15 x v ≤ 1 mm
Position of stiffeners	h _a , h _b , h _{sa} , h _{sb} b _k		±3 mm	±3 mm
Widths of flanges	b _s	D.1.5	+2 mm - 1 mm	+4 mm -1 mm
Cover width	w	D.1.6	h ≤ 50 mm h > 50 mm	± 5,0 mm ± 0,1 x h ≤ 15 mm
Radius of bends	r	D.1.7	+2 mm 0 mm	±2 mm
Length of the profile	l		L ≤ 3000 mm L > 3000 mm	+10 mm -5 mm + 20 mm -5 mm
Deviation of side lap	D	D.1.11	D ≤ ± 2,0 mm on a length of 500 mm	
Longitudinal edge upstand	s		-2 (if s is specified) ≥ 10 mm	
Deflection of flange	f _s		l/300 ≤ 20 mm	
Corner angle flange/web	φ		± 3°	
Lateral curvature	f _q		+ 0,02 x b ≤ 10 mm - 0,01 x b < 10 mm	
Longitudinal corrugation	f _w		b: 400 500 600 f _w : ± 2 mm ± 3 mm ± 5 mm	

Title	Symbols	Test method acc. to EN 508 Annex D	Profiles according to EN 14782 Values of EN 508 or new EPAQ-values (grey)	Profiles according to EN 1090 New EPAQ-values (grey)
Hole diameter	d_n		$\leq \varnothing 5 \text{ mm}$ $> \varnothing 5 \text{ mm}$	$\pm 0,2 \text{ mm}$ $+ 0,2 \text{ mm} \quad -0,4 \text{ mm}$ In case of additional coating after profiling the measurement must be done without additional coating
Hole pitch	u_x		+2,0 / -1,0 mm	
Offset	v		$\pm 2,0 \text{ mm}$	
Row spacing	u_y		$\pm 2,0 \text{ mm}$	
Edge spacing	e_g, e_s			The minimum values to be complied will be specified during ITT
Total number of rows (transversal direction)			± 0 The number must be specified by the manufacturer during ITT $\pm 3\%$ In case of completely perforated sheets	
Total number of rows per meter (longitudinal direction)			$\pm 3\%$ The number must be specified by the manufacturer during ITT	

Table A7: Dimensional tolerances for tiles, test specimens, type of tests and conditions

Title	Symbols	Test method acc. to EN 508 Annex D	Values of EN 508 or new EPAQ-values (grey)
Depth of tile	h	D.3.2	± 2,0 mm
Web angular displacement	α	D.3.3	± 2°
Pitch		D.3.4	h ≤ 75 mm ± 1,5 mm h > 75 mm ± 1,5 mm or 2% of depth
Widths of crown and valley	b	D.3.5	± 1,0 mm
Cover width	w	D.3.6	± 0,005 x w
Radius of bends	r	D.3.7	± 1,5 mm
Deviation from straightness	δ	D.3.8	2,0 mm / m of sheet length not exceeding 9 mm
Deviation from squareness	s	D.3.9	± 6,0 mm
Length	l	D.3.10	± 2,0 mm on each step ± 6,0 mm on total length of the tile
Contracting or bulging	δ	D.3.11	± 2,0 mm/m length ≤ 9 mm

Table A8: FPC procedures for base material and external control

Type of test	Requirement clause of EN 14782	Test Method acc. to EN 14782	FPC		Compliance criteria and specific conditions	External control twice a year
			Minimum number of specimens per batch			Number of specimen
			With traceability system but without base material manufacturer's inspection document ^c	With traceability system and base material manufacturer's inspection document ^c		
Quality of metal ^a	4.1	Visual assessment	1 ^d	1 ^d	Manufacturer's declaration	
Thickness	4.2 and EPAQ	4.2	2 ^d	1 ^d	Manufacturer's declaration	
Mechanical resistance Yield strength/grade of metal	4,3	EN 10002-1	1	- ^b	All test results ≥ manufacturer's stated value (acc. to EN 10326)	3 per type of profile max.20 per year
Durability /quality of the coating	4.8	4.8 and measurement of the thickness of the coating	-	- ^b	Declaration or compliance with appropriate national technical specifications	3 per type of profile max.20 per year
Release of regulated dangerous substances	4.11	-	-	-	As appropriate when national provisions exist	

a This concerns the quality of the base material (no pin-holes, micro-holes, pits, etc.).
b In this case, the finished product manufacturer shall verify that the inspection document in accordance with EN 10204 indicates that the base material (e. g. coils, sheets) has the characteristics that he need to produce the finished product.
c Inspection document 3.1 in accordance with EN 10204
d At each change of profile and change of sheet thickness

Table A9: FPC procedures for profiles and external control

Type of test	Requirement clause of EN 14782	Test Method acc. to EN 14782	FPC		External control twice a year
			Minimum number of specimens	Compliance criteria and specific conditions	Number of specimen
Mechanical resistance Resistance to concentrated forces ^e	4.3	Annex B	1 per year ^d	All test results \geq manufacturer's stated value: a span compatible with a force of 1,2 kN	1 per year ^d
Dimensional tolerances	4.7 and EPAQ	See 4.7	At each change of profile or material and shift ^a	All test results within the EPAQ's tolerances	For each type of profile at 2 profiles for a thinner, a middle and a thicker gauge ^c
Water permeability	4.4	Visual inspections	Continuous	Pass	-
External fire performance ^e	4.9	-	- ^b	To ensure production remains representative of ITT samples	-
Reaction to fire	4.10	-	- ^b	To ensure production remains representative of ITT samples	-

a The profile shall be checked directly at the beginning of each production run, change of coil and/or new shift. The following geometrical characteristics shall be checked at the beginning of each run: the cover width, the height of the ribs, length of profile, the distance between two consecutives ribs, longitudinal edge width and type and position of perforated area. The radius of the profile, the position of the stiffeners, the height of stiffeners of any flat part, webs, the width of the flat part and the cut angle of the sheet have only to be checked during external control.

b No direct testing of these characteristics is needed. However, the manufacturer shall check, with a frequency, to be defined in the FPC manual, sufficient to ensure that ITT results remain applicable to all products. When using CWFT or deemed-to-satisfy, indirect checks of product parameters may be needed.

c It is not necessary to check all profiles at each external control, it is sufficient to check each type of profile at least within a period of two years.

d No testing required for a given profile if the physical dimensions of the product are subject to regular checking.

e Applies only to roofing products.

Annex B

B.1 Dimensions of trapezoidal profiles

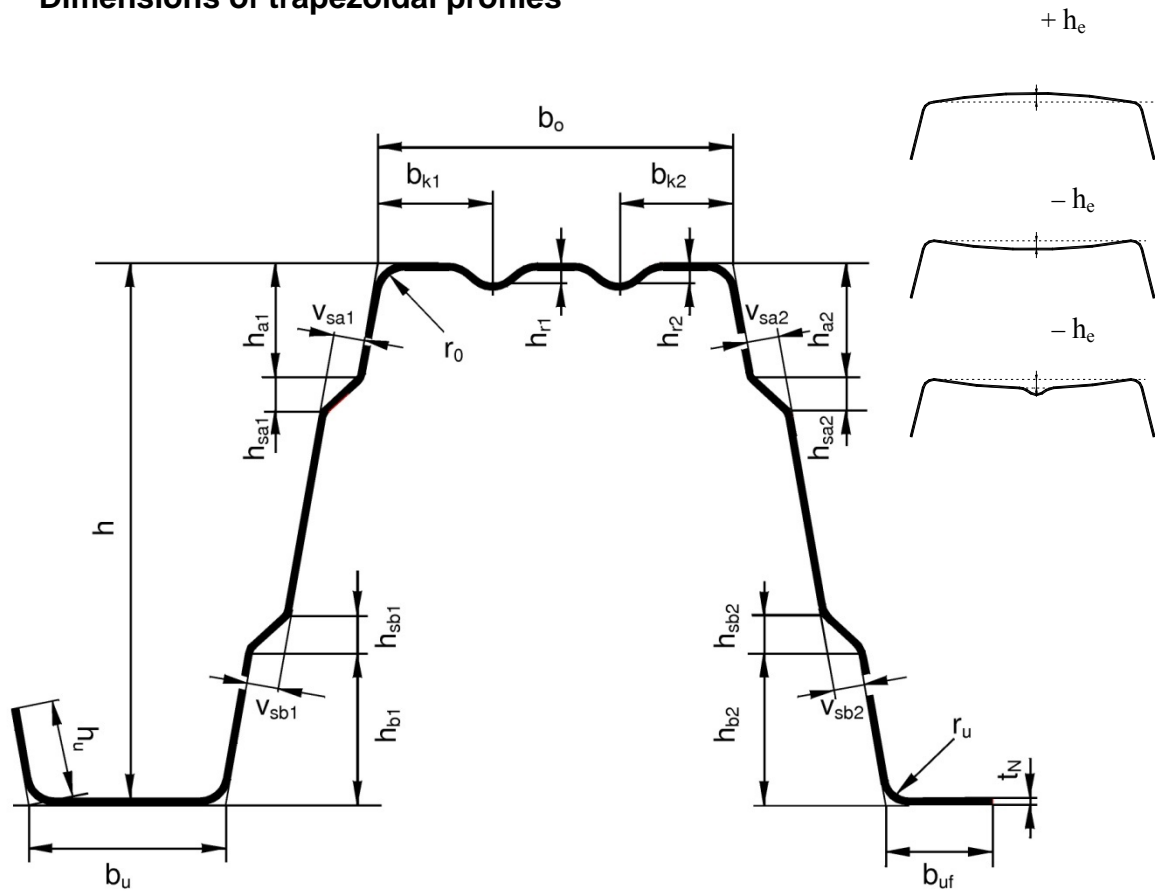

Figure B1.1: Cross section - trapezoidal sheet

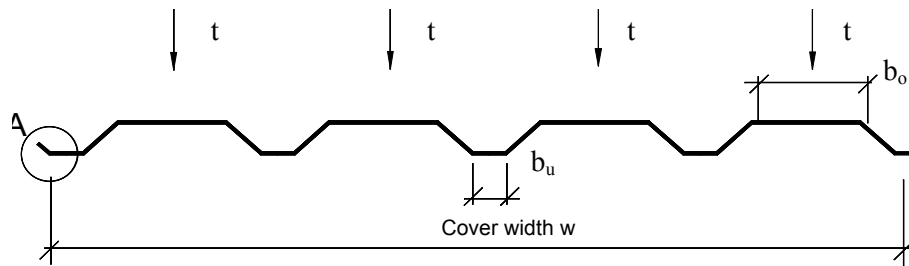

Figure B1.2: Measuring points for sheet thickness t and deviation of sidelap D

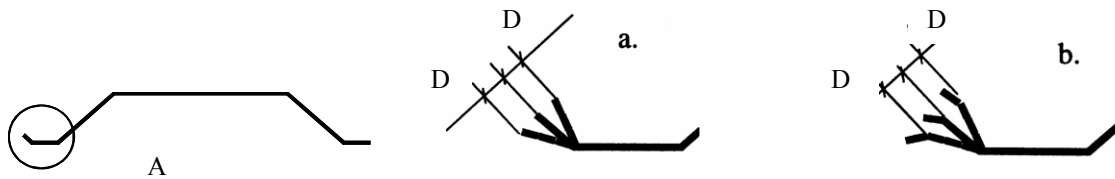

Figure B1.3: Deviation of side lap D

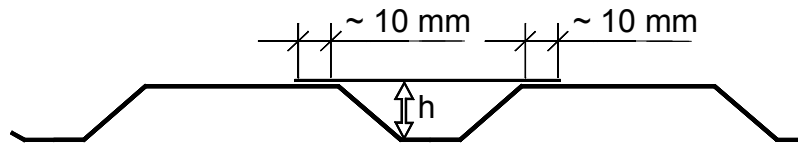
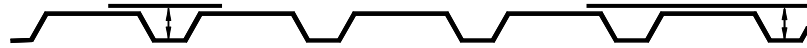
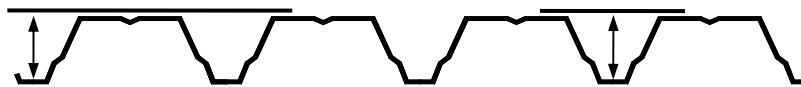

Figure B1.4: Measurement of the depth of profile h

5 Ribs



4 Ribs



3 Ribs



Figure B1.5: Measuring points for depth of profile h

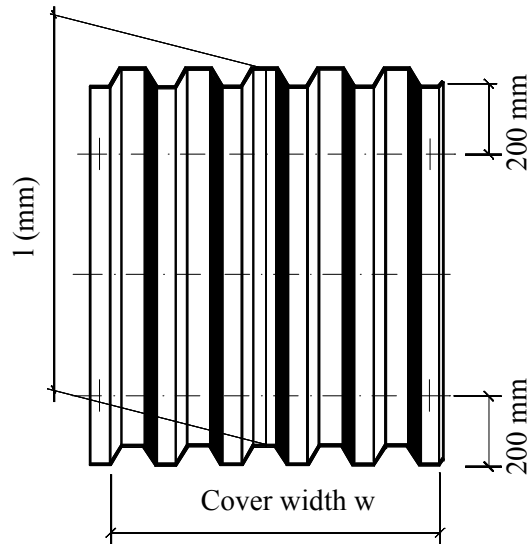

Note: Measurement of length of profile at the middle rib(s)

Figure B1.6: Measurement of the cover width w at both ends and the contraction or bulging w_3 in the middle of the profile

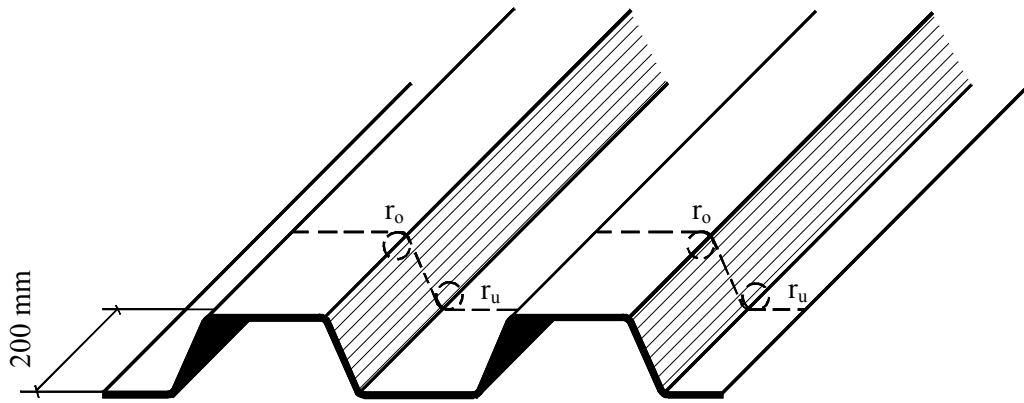
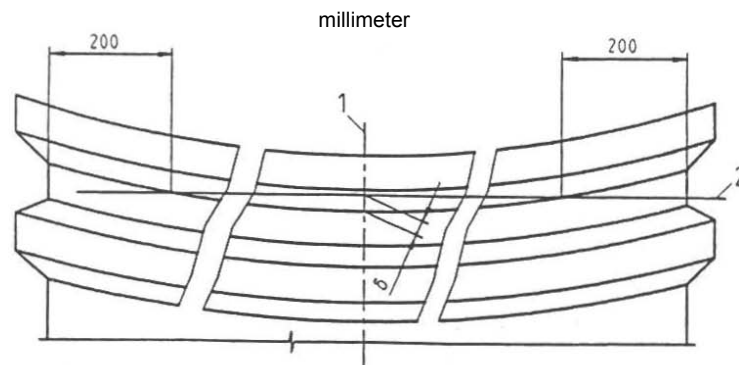

Figure B1.7: Measurement of radius of bends r



- 1 central axis
- 2 straight line at the edge of crown
- δ Deviation of crown from the ideal straight line

Figure B1.8: Measurement of deviation from straightness δ

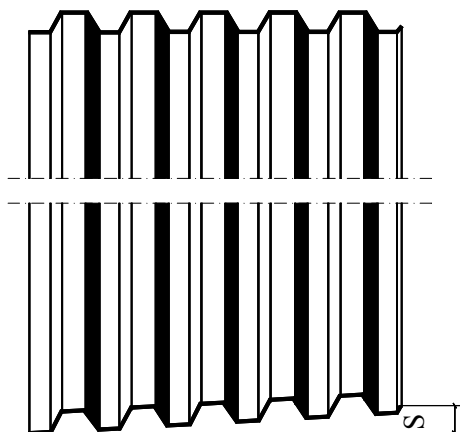

Figure B1.9: Measurement of deviation from squareness S

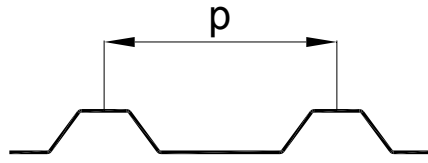
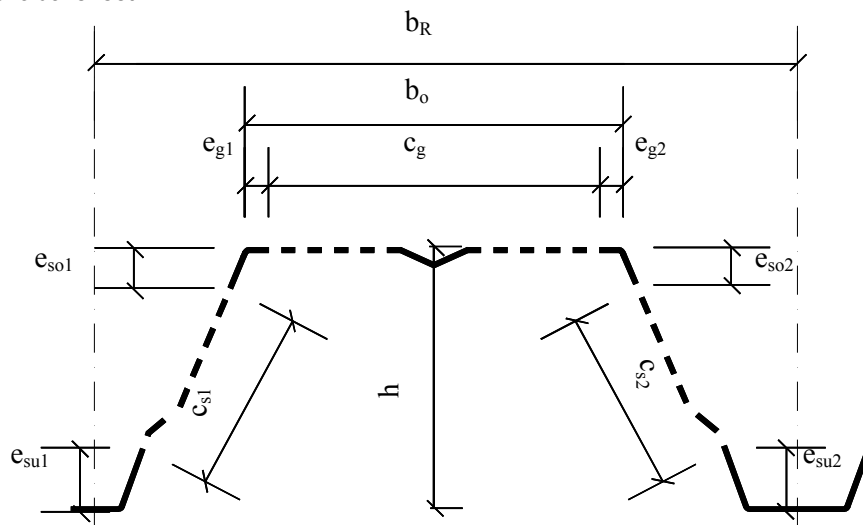
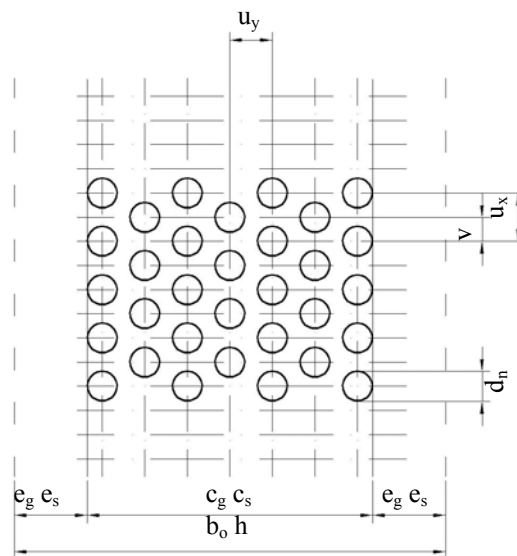

Figure B1.10: Pitch of the profile

Cross section trapezoidal sheet



Holes



d_n = Hole diameter
 t = Hole pitch

Figure B1.11: Acoustic profiles

B.2 Dimensions of sinusoidal profiles

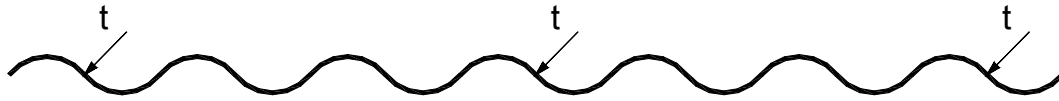

Figure B2.1: Measuring points for sheet thickness t

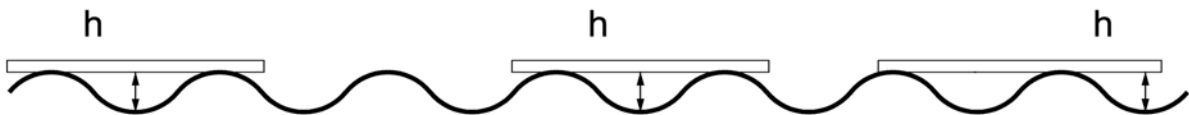

Figure B2.2: Measurement of the depth of profile h

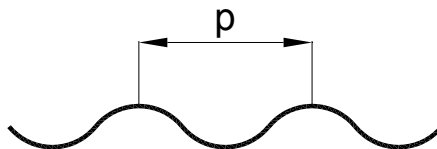

Figure B2.3: Measurement of the pitch of the profile p

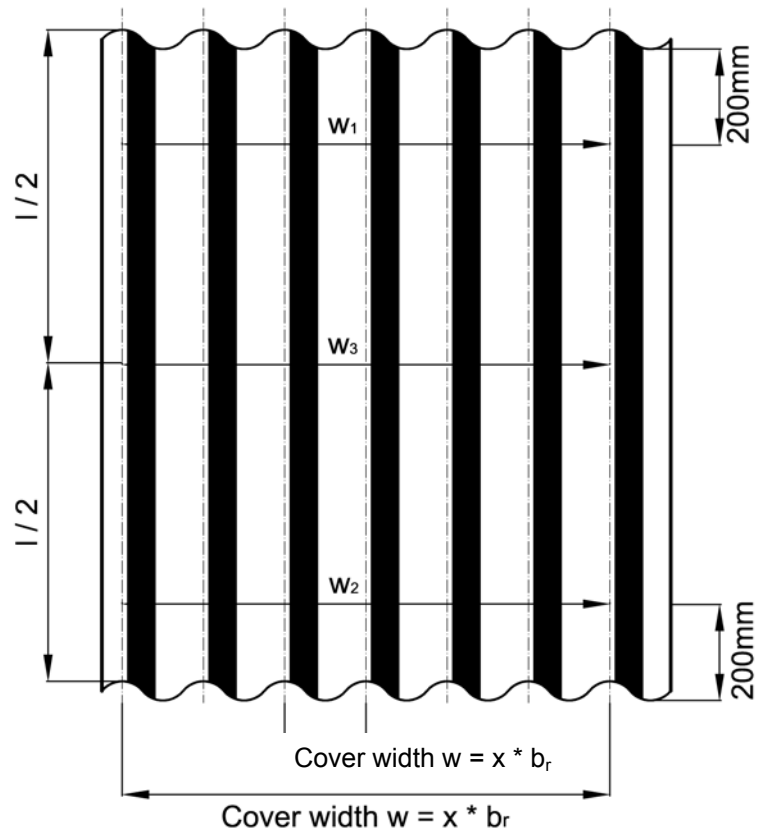

Figure B2.4: Measurement of cover width w at both ends and of the contraction or bulging w_3 in the middle of the profile

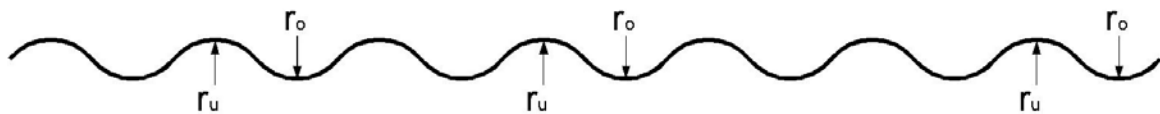
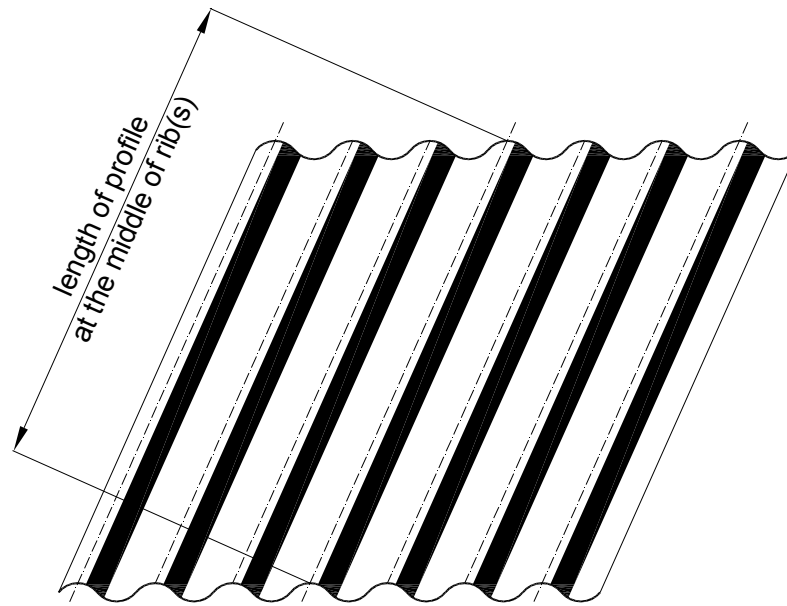

Figure B2.5: Measurement of radius of bends r



FigureB2.6: Measurement of length of profile at the middle rib(s)

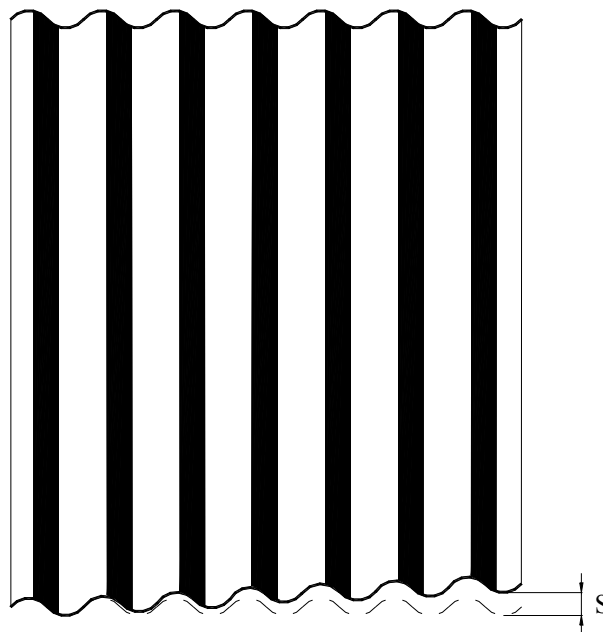

Figure B2.7: Measurement of deviation from squareness S

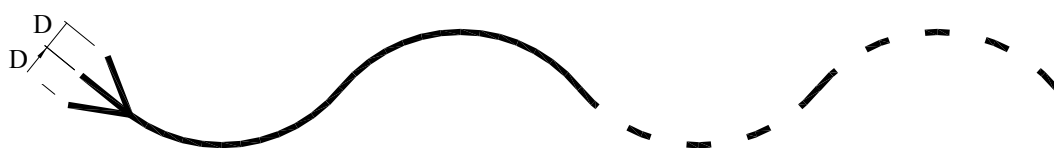

Figure B2.8: Deviation of side lap D

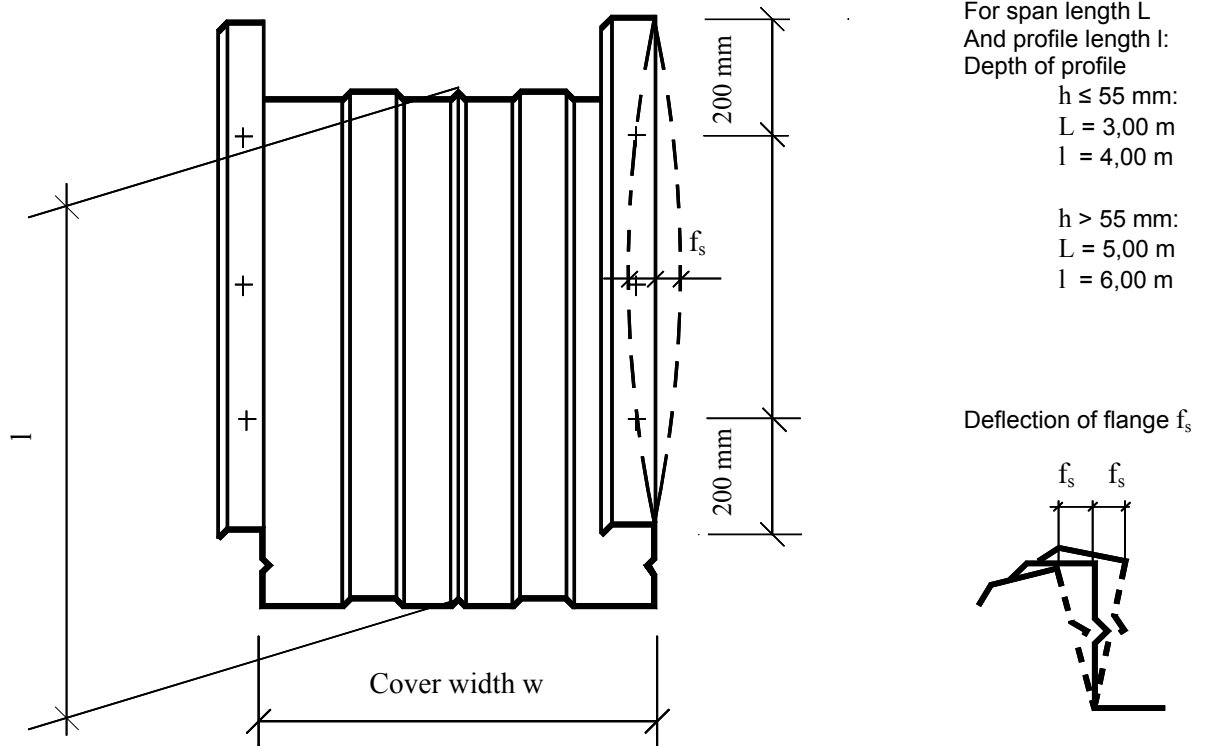

Figure B3.3: Measurement of cover width w, length of profile l and deflection of flange f_s



Figure B3.4: Deviation of side lap D

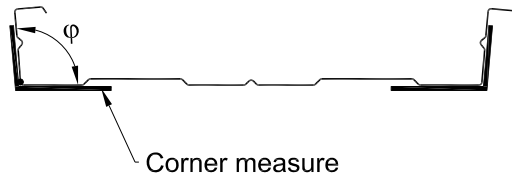

Figure B3.5: Measurement of corner angle flange/web

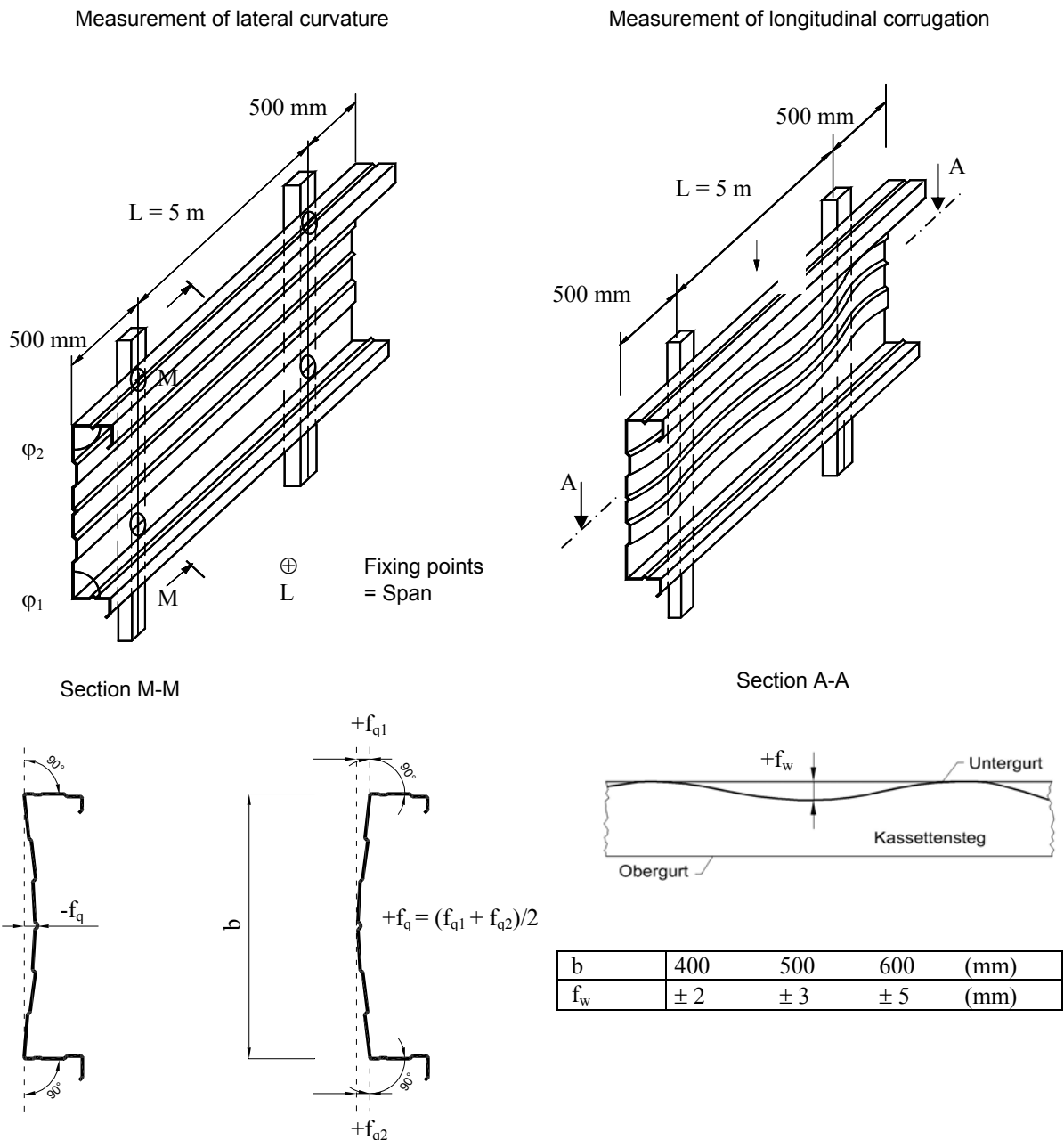
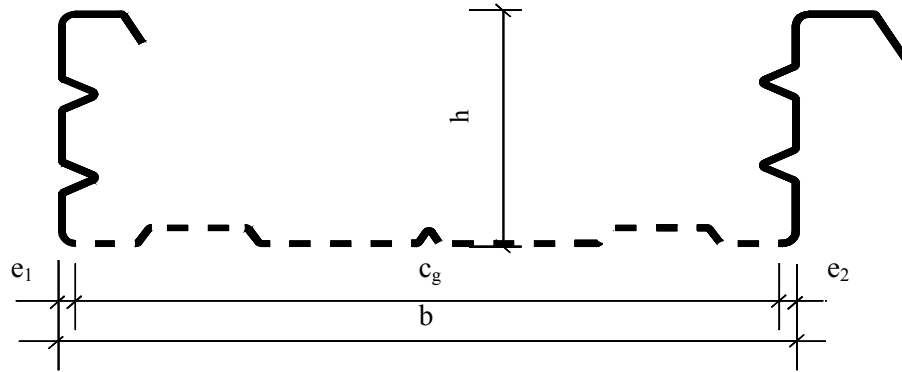

Figure B3.6: Measurement of the lateral curvature

Cross section liner tray



Holes

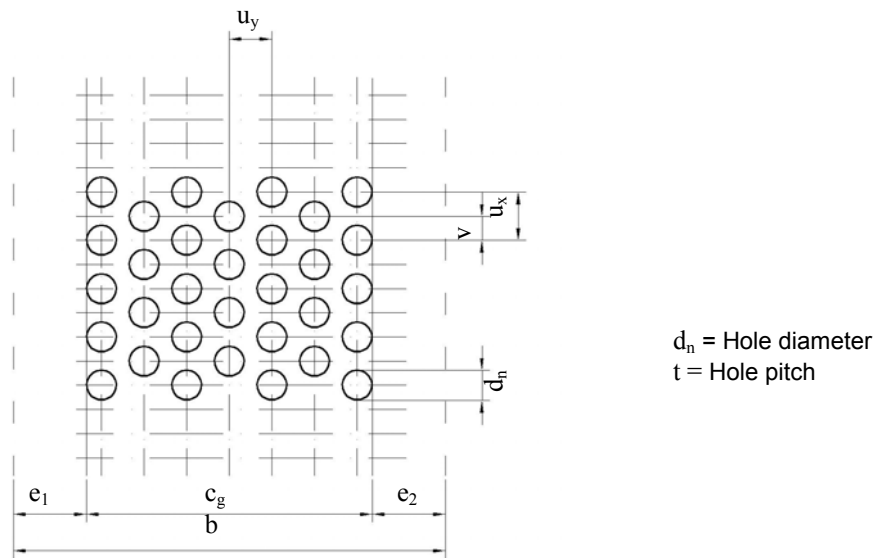

Figure B3.7: Acoustic profiles